

# Ventilación

Fan • Ventilateur

## 2024

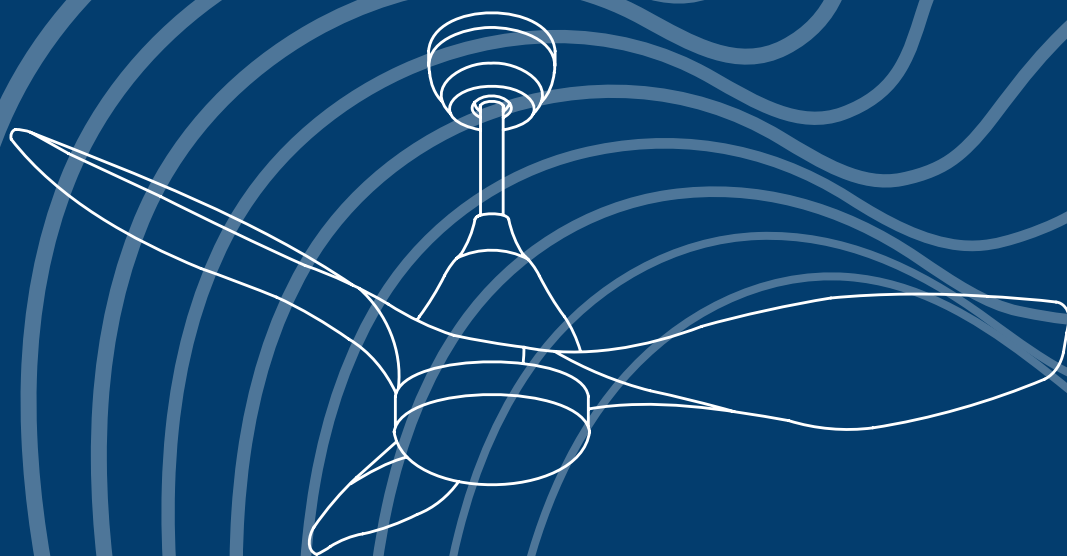

**CristalRecord**  
Iluminación - Lighting



# Ventilación

Fan · Ventilateur

# 2024



**CristalRecord**  
Iluminación - Lighting

# Índice por estancias

*Index for rooms*

*Index par séjour*

## 1. Tamaño estancia <13m<sup>2</sup> *Room size <13m<sup>2</sup>*

 *Taille de la chambre <13m<sup>2</sup>*



Rafale p.134



Iris p.132



Strike p.120



Greip p.136



Moli p.130



Cobra p.122



Dinirot p.124



Tivoli p.126



Corpi p.128



Yoli p.138



Julie p.72



Moll p. 68



Byan Mini p.78



Villa p. 66



Epona p.74



Reel p.70



Orion p.116



Tabit p.114



Antila Mini Xs p.38



Antila Mini Xs Rgb p.38





Stel Mini S p.80



Vera Mini p.28



Antila Mini p.36



Antila Mini Rgb p.36



Byan p.76



Lander Mini p.42



Moss Mini p.50



Panam Mini p.60



Taoro Mini p.32



Stel Mini p.82



Beta p.86



Splash p.140



Brise p.141



Nikiya p.142



## 2. Tamaño estancia 13-20m<sup>2</sup> Room size 13-20m<sup>2</sup>

🏠🏠🏠 Taille de la chambre 13-20m<sup>2</sup>



Aneto p.46



Antila p.34



Antila Rgb p.34



Areca p.24



Lander p.40



Moss p.48



Noe p.90



Panam p.58



Taoro p.30



Terre p.88



Vera p.26



Oku p.44



Naira p.54



Movic p.56



Mince p.20



Ecoro p.64



Supereco p.62



Batan p.22



Tanik p.92



Stel p.84



Surat p.100

# 3. Tamaño estancia >20m<sup>2</sup>

*Room size >20m<sup>2</sup>*  
*Taille de la chambre >20m<sup>2</sup>*



Moss XXL p.52



Aran p.96



Lighter p.98



Tempo p.94



Yen p.106



Enna p.102



Palm p.110



Taga p.104



Yen big p.108



Storm p.112





Bigben p.118







# Índice de referencias

*Reference index*

*Index des références*

Ref.		
85-000-12-000	Splash	140
85-002-52-100	Enna Blanco	102
85-002-52-180	Enna Negro	102
85-002-80-000	Brise	141
85-003-04-180	Greip	136
85-007-20-100	Villa	66
85-009-50-100	Dinirot Blanco	124
85-009-50-180	Dinirot Negro	124
85-010-20-100	Surat	100
85-010-20-200	Surat	100
85-011-36-000	Lander Mini Blanco	42
85-011-36-180	Lander Mini Negro	42
85-011-36-281	Lander Mini Plata	42
85-011-42-000	Lander Blanco	40
85-011-42-180	Lander Negro	40
85-011-42-281	Lander Plata	40
85-020-20-000	Yen Blanco - Madera Clara	106
85-020-20-002	Yen Cuero - Madera	106
85-020-20-003	Yen Cuero - Madera	106
85-020-20-180	Yen Negro - Madera Oscura	106
85-021-36-102	Panam Mini Blanco - Madera Clara	60
85-021-36-106	Panam Mini Blanco - Ceniza	60
85-021-36-180	Panam Mini Blanco - Madera Oscura	60
85-021-42-102	Panam Blanco - Madera Clara	58
85-021-42-106	Panam Blanco - Ceniza	58
85-021-42-180	Panam Blanco - Madera Oscura	58
85-030-20-180	Taga	104
85-033-36-000	Batan Blanco	22
85-033-36-006	Batan Madera	22
85-033-36-006	Batan Negro	22
85-040-03-100	Storm	112
85-060-03-002	Yen big Madera Clara	108
85-060-03-003	Yen big Madera Oscura	108
85-065-46-000	Moss Mini Blanco	50

Ref.		
85-065-46-002	Moss Mini Niquel	50
85-065-46-006	Moss Mini Cuero	50
85-065-46-180	Moss Mini Negro	50
85-065-46-281	Moss Mini Gris	50
85-065-72-000	Moss Blanco	48
85-065-72-002	Moss Niquel	48
85-065-72-006	Moss Cuero	48
85-065-72-180	Moss Negro	48
85-065-72-281	Moss Gris	48
85-066-72-000	Aneto Blanco	46
85-066-72-002	Aneto Niquel	46
85-066-72-006	Aneto Cuero	46
85-066-72-180	Aneto Negro	46
85-066-72-186	Aneto Gris	46
85-068-45-100	Moss XL Blanco	52
85-069-25-100	Ecoro Blanco	65
85-069-25-180	Ecoro Negro	65
85-069-42-000	Supereco Blanco	62
85-069-42-180	Supereco Negro	62
85-090-36-106	Beta	86
85-091-52-108	Palm	110
85-094-22-100	Antila Mini Xs Rgb Blanco	38
85-094-22-180	Antila Mini Xs Rgb Negro	38
85-094-22-281	Antila Mini Xs Rgb Gris	38
85-094-36-000	Antila Mini Rgb Blanco	36
85-094-36-180	Antila Mini Rgb Negro	36
85-094-36-281	Antila Mini Rgb Gris	36
85-094-42-000	Antila Rgb Blanco	34
85-094-42-180	Antila Rgb Negro	34
85-094-42-281	Antila Rgb Gris	34
85-101-42-106	Movic	56
85-102-22-100	Epona Blanco	74
85-102-22-106	Epona Blanco Madera	74
85-102-22-180	Epona Negro	74

Ref.		
85-102-22-100	Epona Negro Madera	74
85-102-22-106	Julie Blanco	74
85-102-22-180	Julie Blanco - Madera	74
85-102-22-188	Byan Mini Blanco	78
85-104-66-100	Byan Mini Blanco - Madera	78
85-104-66-102	Byan Mini Blanco - Gris	78
85-108-60-100	Byan Mini Negro - Madera	78
85-108-60-102	Byan Blanco	76
85-108-60-105	Byan Blanco - Madera	76
85-108-60-180	Byan Blanco - Gris	76
85-108-92-100	Byan Negro - Madera	76
85-108-92-102	Oku Blanco	44
85-108-92-105	Oku Negro	44
85-108-92-180	Oku Plata	44
85-114-42-100	Tanik Blanco	92
85-114-42-180	Tanik Marron	92
85-114-42-281	Tanik Gris	92
85-160-25-100	Corpi	128
85-160-25-115	Lighter	98
85-160-25-281	Areca Niquel	24
85-201-35-000	Areca Blanco	24
85-203-24-100	Naira Blanco	54
85-298-48-002	Naira Negro	54
85-298-48-100	Noe	90
85-301-10-100	Vera Mini	28
85-400-22-100	Reel - Blanco	70
85-400-22-180	Reel - Negro	70
85-401-22-100	Moll Blanco	68
85-401-22-106	Moll Blanco - Madera	68
85-401-22-180	Moll Negro	68
85-401-22-188	Moll Negro - Madera	68
85-402-40-100	Antila Mini Blanco	36
85-402-40-180	Antila Mini Negro	36
85-402-40-281	Antila Mini Gris	36
85-403-40-100	Antila Mini Xs Blanco	38
85-403-40-180	Antila Mini Xs Negro	38
85-403-40-281	Antila Mini Xs Gris	38
85-405-40-100	Antila Blanco	34
85-405-40-180	Antila Negro	34
85-405-40-281	Antila Gris	34
85-485-52-100	Tempo Blanco	94
85-485-52-281	Tempo Gris	94

Ref.		
85-500-36-000	Taoro Mini Blanco	32
85-500-36-180	Taoro Mini Negro	32
85-500-42-000	Taoro Blanco	30
85-500-42-180	Taoro Negro	30
85-503-40-115	Yoli Marron	138
85-503-40-281	Yoli Plata	138
85-556-32-000	Moli	130
85-589-36-100	Iris	132
85-616-40-100	Vera	26
85-617-42-100	Mince	20
85-657-36-100	Aran	96
85-790-06-100	Tabit Blanco	114
85-790-06-115	Tabit Cuero	114
85-790-06-281	Tabit Plata	114
85-790-06-666	Tabit Multicolor	114
85-908-42-100	Terre Blanco	88
85-908-42-115	Terre Niquel	88
85-908-42-180	Terre Negro	88
85-915-20-100	Stel Mini S Blanco	80
85-915-20-106	Stel Mini S Blanco Pala Clara	80
85-915-20-180	Stel Mini S Negro	80
85-915-20-188	Stel Mini S Negro Pala Oscura	80
85-917-52-106	Tivoli	126
85-921-40-180	Rafale	134
85-922-50-180	Strike	120
85-924-30-100	Cobra Blanco	122
85-924-30-180	Cobra Negro	122
85-925-20-100	Stel Mini Blanco	82
85-925-20-100	Stel Mini Blanco - Madera	82
85-925-20-180	Stel Mini Negro	82
85-925-20-180	Stel Mini Negro - Madera	82
85-950-20-100	Stel Blanco	84
85-950-20-106	Stel Blanco Madera	84
85-950-20-180	Stel Negro	84
85-950-20-188	Stel Negro Madera	84
85-960-18-106	Bigben 180cm	118
85-960-25-106	Bigben 250cm	118
85-970-30-100	Nikiya Blanco	142
85-970-30-666	Nikiya Multicolor	142
85-990-06-111	Orion Blanco - Ceniza	116
85-990-06-666	Orion Multicolor	116

# Que debemos saber sobre ventilación.

*What should we know on ventilation.  
Que devrions-nous savoir sur la ventilation.*

## 1. Los tipos de aspas *The types of blades Les types de lames*



### 1. Ventiladores con palas Retráctil

Elegantes en su modo parado, un gran flujo de aire y muy buena iluminación. Encuentra el modelo que mejor se adapte a ti, gracias a las tecnologías que incorporamos.

#### *Ceiling fans with retractable blades*

*Elegant when stationary, great airflow and very good lighting. Find the model that best suits you, thanks to the technologies we incorporate.*

#### *Ventilateur de plafond avec pales retractables*

*Élégant à l'arrêt, grand débit d'air et très bon éclairage. Trouvez le modèle qui vous convient le mieux, grâce aux technologies que nous intégrons.*





## 2. Ventiladores con aspas

Son atemporales, inunca pasan de moda y cumplen con todas tus necesidades! variedad de materiales y tamaños, desde estilos modernos a tendencias más naturales.

### *Fans with blades*

*They are timeless, never go out of fashion and meet all your needs! variety of materials and sizes, from modern styles to more natural trends.*

### *Ventilateurs à pales*

*Ils sont intemporels, ne se démodent jamais et répondent à tous vos besoins ! variété de matériaux et de tailles, des styles modernes aux tendances plus naturelles*



## 3. Ventiladores tipo plafón

Con las palas protegidas por una estructura exterior son ideales para habitaciones infantiles, con o sin literas. Son discretos, divertidos, con una variedad de funciones y un flujo de aire concentrado en el centro o concentrado disperso.

### *Flush ceiling fan*

*With the blades protected by an external structure, they are ideal for children's rooms, with or without bunk beds. They are discreet, fun, with a variety of functions and a concentrated airflow in the centre or dispersed concentrate.*

### *Ventilateur de plafond*

*Plus de la fonction avec les lames protégées par une structure externe, ils sont idéaux pour les chambres d'enfants, avec ou sans lits superposés. Ils sont discrets, amusants, avec une variété de fonctions et un flux d'air concentré ou concentré dispersé.*

## 2. Flujos de aire

*Air flows*  
*Flux d'air*



### 1. Amplio

¿Quieres mover todo el aire de una estancia? Este tipo de flujo es el ideal. Fuerte flujo externo y suave por la parte central.

#### *Wide*

Do you want to move all the air in a room? This type of flow is ideal. Strong external flow and smooth central flow.

#### *Large*

Vous souhaitez déplacer tout l'air d'une pièce? Ce type de flux est idéal. Un flux externe puissant et un flux central doux.



### 2. Concentrado

¿Quieres un flujo directo y concentrado? Con estos ventiladores notarás aire directo justo debajo del ventilador.

#### *Concentrated*

Do you want a direct and concentrated flow? These models are what you are looking for. You will notice how the air flows downwards, being softer on the outside.

#### *Concentré*

Vous voulez un flux direct et concentré? Ces modèles sont ce que vous recherchez. Vous remarquerez que l'air s'écoule vers le bas et qu'il est plus doux à l'extérieur.



### 3. Concentrado disperso 360°

Con su sistema de eje rotativo consigue dispersar el aire por toda la habitación manteniendo el diseño.

#### *360° Dispersed concentrated*

With its rotating shaft system it allows to disperse the air all around the room while maintaining the design.

#### *Concentré dispersé à 360°*

Grâce à son système d'axes rotatifs, il parvient à disperser l'air dans toute la pièce tout en conservant le design.



# 3. Tamaño estancia

*Room size*  
*Taille de la chambre*



## 1. El ventilador perfecto

Sabemos que cada estancia es un mundo, pero para poder guiarte, te presentamos nuestra colección para que puedas elegir el ventilador que mejor se adecue a tu espacio.

### *The perfect ceiling fan*

*We know that every room is different, but in order to guide you, we present our recommendations so that you can choose the fan that best suits your space.*

### *Le ventilateur parfait*

*Nous savons que chaque pièce est différente, mais afin de vous guider, nous vous présentons nos recommandations afin que vous puissiez choisir le ventilateur qui convient le mieux à votre espace.*

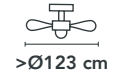

# 4. **Función inversa**

*Reverse function*  
*Foction Inverse*



## 1. Invierno

Girando en sentido antihorario hace descender el aire caliente.

### *Winter*

*Turning anticlockwise causes the warm air to descend.*

### *Hiver*

*Le ventilateur En tournant dans le sens inverse des aiguilles d'une montre, on abaisse l'air chaud.*

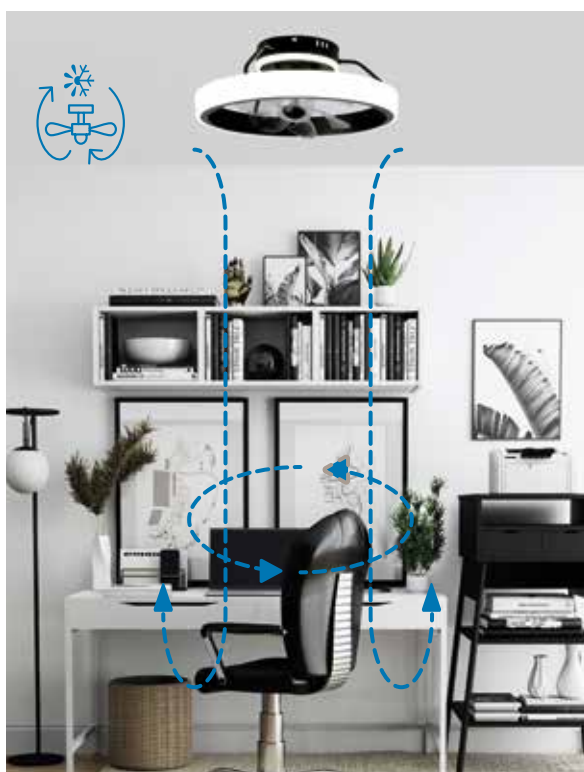

## 2. Verano

El ventilador gira en sentido horario creando un flujo de aire frío descendente.

### *Summer*

*The fan rotates clockwise creating a downward flow of cold air.*

### *Eté*

*Le ventilateur tourne dans le sens des aiguiller d'une*

## 5. Función smart

*Smart function*  
*Fonction smart*

En CristalRecord contamos con una selección de ventiladores que por sus características pueden convertirse en un ventilador Smart de manera muy sencilla. A la hora de instalar el ventilador, hay que sustituir el mando y su correspondiente receptor que vienen incluidos con los ventiladores por nuestro kit-Smart. Ahora tu ventilador puede ser controlado desde tu móvil a través de la App Tuya compatible con Amazon Alexa y Google Assistant.

***“En CristalRecord contamos con una selección de ventiladores smart y varios modelos que por sus características pueden convertirse en un ventilador Smart de manera muy sencilla.”***

*CristalRecord has a selection of fans that can be easily converted into a Smart fan due to their characteristics. When installing the fan, you have to replace the remote control and its corresponding receiver that come included with the fans with our Smart-Kit. Now your fan can be controlled from your mobile phone through the Tuya App compatible with Amazon Alexa and Google Assistant.*

***“CristalRecord has a selection of smart fans and several models that due to their characteristics can be converted into a Smart fan in a very simple way.”***

*CristalRecord propose une sélection de ventilateurs qui, en raison de leurs caractéristiques, peuvent devenir des ventilateurs intelligents de manière très simple. Au moment d'installer le ventilateur, vous devez remplacer la télécommande et son récepteur correspondant qui sont fournis avec les ventilateurs par notre Kit-Smart. Maintenant, votre ventilateur peut être contrôlé sur votre téléphone portable grâce à l'application Tuya, compatible avec Amazon Alexa et Google Assistant.*

***“Chez CristalRecord, nous disposons d'une sélection de ventilateurs intelligents et de plusieurs modèles qui, de par leurs caractéristiques, peuvent être convertis très facilement en ventilateur Smart.***













# Características técnicas

Orden alfabético.

*Technical data. Alphabetical order.*

*Données techniques. Ordre alphabétique.*





					
Aneto	46	106 cm	DC	6	✓
Antila	34	106 cm	DC	6	✓
Antila Rgb	34	106 cm	DC	6	✓
Antila Mini	36	92 cm	DC	6	✓
Antila Mini Rgb	36	92 cm	DC	6	✓
Antila Mini Xs	38	55 cm	DC	6	✓
Antila Mini Xs Rgb	38	55 cm	DC	6	✓
Aran	96	127 cm	DC	6	✓
Areca	24	106 cm	DC	6	✓
Batan	22	107 cm	DC	6	✓
Beta	86	92 cm	DC	6	✓
Bigben	118	180 cm	DC	6	
Bigben	118	250 cm	DC	6	
Byan	76	92 cm	DC	6	✓
Byan Mini	78	60 cm	DC	6	✓
Cobra	122	50 cm	DC	6	✓
Corpi	128	60 cm	DC	6	✓
Dinirot	124	50 cm	DC	6	✓
Ecoro	64	106 cm	DC	6	✓
Enna	102	137 cm	DC	6	✓
Epona	74	64 cm	DC	6	✓
Greip	136	49 cm	DC	6	✓
Iris	132	44 cm	DC	6	✓
Julie	72	56 cm	DC	6	✓
Lander	40	106 cm	DC	6	✓
Lander Mini	42	92 cm	DC	6	✓
Lighter	98	132 cm	DC	6	✓
Mince	20	106 cm	DC	6	✓

	Nº				
2-4 h	2	✓		72W 7920lm CCT	22
2-4 h	2	✓		60W 6000lm CCT	22
1-4 h	2	✓		65W 6500lm CCT+RGB	22
2-4 h	2	✓		40W 4000lm CCT	25
1-4 h	2	✓		45W 4500lm CCT+RGB	25
2-4 h	2	✓		35W 3000lm CCT	35
1-4 h	2	✓		40W 3500lm CCT+RGB	35
1-3-6 h	2			36W 3200lm CCT	18
1-3-6 h	2	✓		45W 3500lm CCT	18
1-3 h	2	✓		35W 3200 lm CCT	18
2-4 h	2			20W 1900lm CCT	42
0,5-2 h	2			20W 2000lm CCT	16
0,5-2 h	2			20W 2000lm CCT	12
2-4 h	2			18W 2000lm CCT	42
2-4 h	2			18W 2000lm CCT	65
2-4 h			✓	50W 4800lm CCT	30
1-4 h			✓	35W 3500lm CCT+RGB	18
2-4 h			✓	50W 4800lm CCT	22
2-4 h	2	✓		45W 4400lm CCT	22
2-4 h	2			24W 2400lm CCT	26
2-4 h			✓	20W 2000lm CCT	75
1-4-8 h			✓	4xE27	22
1-2-4 h			✓	25W 2200lm CCT +RGB	26
1-3 h			✓	20W 2000lm CCT	63
2-4 h	2	✓		72W 7920lm CCT	22
2-4 h	2	✓		46W 5520lm CCT	25
1-2-4-8 h	2			24W 1600lm	16
1-2-4-6-8 h	2	✓		36W 3600lm CCT	22



Moli	130	50 cm	DC	5	✓
Moll	68	56 cm	DC	6	✓
Moss	48	106 cm	DC	6	✓
Moss Mini	50	92 cm	DC	6	✓
Moss XI	52	123 cm	DC	6	✓
Movic	56	106 cm	DC	6	✓
Naira	54	106 cm	DC	6	✓
Noe	90	106 cm	DC	5	
Oku	44	106 cm	DC	6	✓
Orion	116	76 cm	AC	3	
Palm	110	132 cm	DC	6	✓
Panam	58	106 cm	DC	6	✓
Panam Mini	60	92 cm	DC	6	✓
Rafale	134	40 cm	DC	6	✓
Reel	70	66 cm	DC	6	✓
Stel	84	120 cm	DC	6	✓
Stel Mini	82	92 cm	DC	6	✓
Stel Mini S	80	80 cm	DC	6	✓
Storm	112	132 cm	AC	3	
Strike	120	49 cm	DC	6	✓
Supereco	62	106 cm	DC	6	✓
Surat	100	122 cm	DC	6	
Tabit	114	84 cm	AC	3	
Taga	104	132 cm	AC	3	
Tanik	92	115 cm	DC	5	
Taoro	30	106 cm	DC	6	✓
Taoro Mini	32	92 cm	DC	6	✓
Tempo	94	132 cm	DC	5	
Terre	88	106 cm	DC	6	✓
Tivoli	126	50 cm	DC	6	✓
Vera	26	106 cm	DC	6	✓
Vera Mini	28	91 cm	DC	6	✓
Villa	66	55 cm	DC	6	✓
Yen	106	132 cm	DC	6	✓
Yen big	108	152 cm	DC	6	✓
Yoli	138	50 cm	DC	6	✓



	Nº				
1-2 h			✓	35W 3300lm CCT+RGB	22
2-4 h			✓	20W 1900lm CCT	48
2-4 h	2	✓		72W 7920lm CCT	22
2-4 h	2	✓		46W 5520lm CCT	25
2-4 h	2	✓		80W 9000lm CCT	15
2-4 h	2	✓		72W 7920lm CCT	22
2-4 h	2	✓		50W 6000lm CCT	22
1-2-4-8 h	2			18W 1500lm CCT	30
2-4 h	2	✓		70W 7920lm CCT	22
	1		✓	1xE27	48
2-4 h	2			25W 2200lm CCT	26
2-4 h	2	✓		72W 7920lm CCT	22
2-4 h	2	✓		46W 5520lm CCT	25
2-4 h			✓	50W 4800lm CCT	48
2-4 h			✓	20W 1900lm CCT	40
2-4-8 h	2			20W 1900lm CCT	36
2-4-8 h	2			20W 1900lm CCT	42
2-4 h	2			20W 1900lm CCT	56
1-2-4-8 h	1				24
2-4 h			✓	50W 4800lm CCT	30
2-4 h	2	✓		45W 4400lm CCT	22
0,5-2 h			✓	18W 2000lm CCT	28
	1		✓	1xE27	42
1-2-4-8 h	1			18W 1500lm CCT	26
1-4-8 h	1			24W 2300lm CCT	24
2-4 h	2	✓		72W 7920lm CCT	22
2-4 h	2	✓		46W 5520lm CCT	25
1-4-8 h	2		✓	22W 1600lm CCT	30
0,5-2 h	2			22W 1600lm CCT	30
2-4 h			✓	50W 5200lm CCT	22
1-2-4-6-8 h	2	✓		30+10W 2400+500lm CCT	22
1-2-4-6-8 h	2	✓		30+10W 2400+500lm CCT	24
1-2-4 h		✓	✓	18W 2400 lm CCT	42
0,5-2 h			✓	15W 1500lm CCT	28
0,5-2 h	2			18W 1600lm CCT	18
1-2-4-8 h			✓	40W 2800lm CCT	18













# Datos técnicos

*Technical data*

*Données techniques*





















## 1. Simbología

*Symbology*  
*Symbologie*

	Motor	Motor	Moteur
	Velocidades	Speeds	Vitesses
	Función inversa verano/invierno	Inverse function summer/winter	Fonction inverse été/hiver
	Función brisa	Breeze function	Fonction brise
	Flujos de aire amplio	Air flows wide	Flux d'air large
	Flujos de aire concentrado	Air flows concentrated	Flux Dd'air concentré
	Flujo concentrado disperso	Air flows dispersed concentrated	Flux d'air concentré dispersé
	Temporizador	Timer	Temporisateur
	Smart	Smart	Smart
	RGB	RGB	RGB
	Máxima inclinación de instalación	Maximum installation inclination	Inclinaison maximale de l'installation
	Número de tijas	Number of posts	Quantité de postes
	Madera natural	Natural wood	Bois naturel

	Montaje directo a techo	Direct ceiling mounting	Montage direct au plafond
	Fácil instalación	Easy installation	Installation facile
	Número de palas	Number of blades	Quantité de lames
	Palas reversibles	Reversible blades	Lames réversibles
	Palas plegables u ocultas	Retractable or cover blades	Lames repliables ou cachées
	LED integrado	Integrated LED	LED intégrée
	Bombilla	Bulb	Ampoules
	Tres tonos de luz	Three light tones	Trois couleurs de lumière
	Dimmable	Dimmable	Dimmable
	Memoria de encendido	Switch-on light memory	Mémoire éclairée
	Tamaño de la habitación recomendado	Recommended room size	Surface de la pièce recommandée
	Diámetro del ventilador	Fan diameter	Diamètre du ventilateur
	Iluminación	Lighting	Éclairage



	Material del cuerpo	<i>Body material</i>	<i>Matériau du corps</i>
	Motor	<i>Motor</i>	<i>Moteur</i>
	Material del difusor	<i>Diffuser material</i>	<i>Matériau du diffuseur</i>
	Material de las palas	<i>Blade material</i>	<i>Matériau de la lame</i>
	Peso	<i>Weight</i>	<i>Poid</i>
	Unidades por palet	<i>Units per pallet</i>	<i>Unités par palette</i>
	Doble encendido	<i>Combined lighting</i>	<i>Éclairage par minute</i>
	Patentado	<i>Proprietary</i>	<i>Propriétaire</i>
	Registrado	<i>Registered</i>	<i>Inscrit</i>
	Revoluciones por minuto	<i>Revolutions per minute</i>	<i>Révolutions par minute</i>
	Flujo de aire m <sup>3</sup> /hora	<i>Airflow m<sup>3</sup>/hour</i>	<i>Débit d'air m<sup>3</sup>/heure</i>
	Consumo (W)	<i>Consumption (W)</i>	<i>Consommation (W)</i>
	Decibelios	<i>Decibels</i>	<i>Décibels</i>
	Mando a distancia	<i>Remote control</i>	<i>Télécommande</i>
	IP 44	<i>IP 44</i>	<i>IP 44</i>
	Bluetooth	<i>Bluetooth</i>	<i>Bluetooth</i>
	Altavoz	<i>Speaker</i>	<i>Haut-parleur</i>
	Garantía motor	<i>Engine warranty</i>	<i>Garantie moteur</i>
	Garatía LED	<i>LED guarantee</i>	<i>Garantie LED</i>
	Modo noche	<i>Night mode</i>	<i>Mode nuit</i>
	Página	<i>Page</i>	<i>Page</i>

## 2. Acabados

### *Finishes*

### *Finitions*

	Blanco	<i>White</i>	<i>Blanc</i>
	Plata	<i>Silver</i>	<i>Argent</i>
	Niquel	<i>Nickel</i>	<i>Nickel</i>
	Gris	<i>Grey</i>	<i>Gris</i>
	Negro	<i>Black</i>	<i>Noir</i>
	Marrón	<i>Brown</i>	<i>Brun</i>
	Madera clara	<i>Light wood</i>	<i>Bois clair</i>
	Madera oscura	<i>Dark wood</i>	<i>Bois sombre</i>
	Wengue	<i>Wengue</i>	<i>Wengue</i>
	Madera ceniza	<i>Ash wood</i>	<i>Bois de frêne</i>
	Cuero viejo	<i>Leather old</i>	<i>Cuir vieux</i>
	Multicolor	<i>Multicolored</i>	<i>Multicolore</i>
	Multicolor Pastel	<i>Multicolored Pastel Color</i>	<i>Multicolore Couleur pastel</i>

★New★

 MOTOR DC

 36W 3600Lm

# Mince





○ 85-617-42-100



MD-85-017-52  
2xAAA

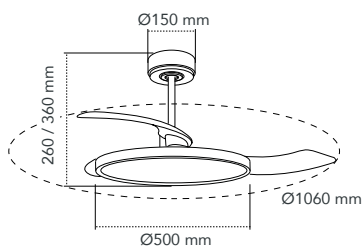

ABS   
 Acero/Steel/Acier   
 PMMA   
 5 Kg   
 22 Uds.

	1	2	3	4	5	6
	140	159	180	199	219	230
m³/h	3140	4560	5450	6210	6775	7345
(W)	3	6	10	17	32	35
	28	32	35	38	42	46

# Batan





○ 85-033-36-000

○ ● 85-033-36-006

★ **New** ★



● 85-033-36-008



MD-85-233-36  
2xAAA

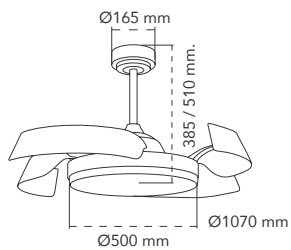

	1	2	3	4	5	6
	1	2	3	4	5	6
	110	121	132	143	154	164
m³/h	6540	7200	8100	8940	10560	10800
(W)	4	5	7	12	19	34
	19	23	28	32	35	38



# Areca





○ 85-298-48-100



● 85-298-48-002



MD-85-298-48  
1x12V

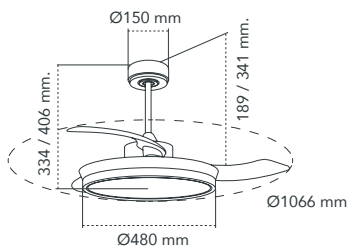

	1	2	3	4	5	6
	180	190	200	215	230	250
m³/h	6600	7200	7800	8400	9000	9900
(W)	4	5	6	8	12	18
	43	44	44	45	46	47

# Vera







○ 85-616-40-100



MD-85-316-40  
2xAAA

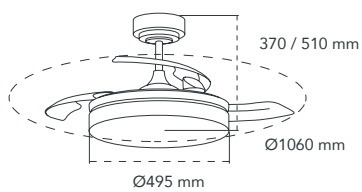

	1	2	3	4	5	6
	167	178	188	200	210	220
m³/h	3500	4600	5500	7500	8400	9200
(W)	8	10	12	15	18	24
	18	22	25	28	32	36

# Vera Mini





○ 85-316-40-100



	1	2	3	4	5	6
	172	187	203	217	231	246
m <sup>3</sup> /h	3200	4200	5100	6100	7300	8400
(W)	3	5	8	10	13	18
	16	20	22	25	30	35

★New★



 Natural Wood  72W 7920Lm

# Taoro



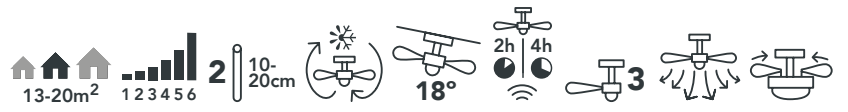

○ 85-500-42-000

● 85-500-42-180



MD-85-065-92  
2xAAA

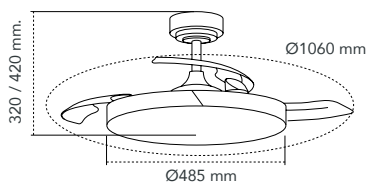

PC   
 Acero/Steel/Acier   
 PMMA   
 5,5 Kg   
 22 Uds.

	1	2	3	4	5	6
	175	186	195	212	227	245
m³/h	3420	4050	4500	5760	6120	6700
(W)	6,8	8	9,5	14	18,2	29
	28	30	33	34	37	40

★New★

 MOTOR DC

 Natural Wood  46W 5520Lm

# Taoro Mini







**Palas Retráctiles**

Elegantes en su modo parado, un gran flujo de aire y muy buena iluminación.

**Retractable Blades**

Elegant when stationary, great airflow and very good lighting.

**Pales Retractables**

Élégant à l'arrêt, grand débit d'air et très bon éclairage.

○ 85-500-36-000



● 85-500-36-180



MD-85-065-46  
2xAAA

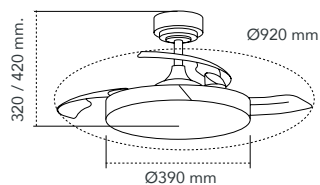

	1	2	3	4	5	6
	164	187	208	226	245	260
m <sup>3</sup> /h	2340	2520	3060	3600	4770	5580
(W)	5	7.2	9.4	12.3	15.7	20
	27	29	32	33	36	39

# Antila



## Color RGB

Con esta colección podrá disfrutar de 16 ambientes diferentes en colores RGB, seleccionándolos desde el mando. La iluminación de los aros decorativos es fija en luz natural de 4000K.

### RGB color

*With this collection you can enjoy 16 different atmospheres in RGB colours, selected from the remote control. The lighting of the decorative rings is fixed in 4000K daylight.*

### Couleur RGB

*Avec cette collection, vous pourrez profiter de 16 environnements différents aux couleurs RVB, en les sélectionnant depuis la télécommande. L'éclairage des anneaux décoratifs est fixé à 4000K lumière naturelle.*





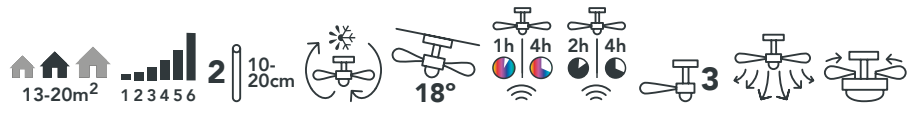

● ○ 85-094-42-000 **★New★**
● ● 85-094-42-180 **★New★**
● ● 85-094-42-281 **★New★**



○ 85-405-40-100

● 85-405-40-180

● 85-405-40-281

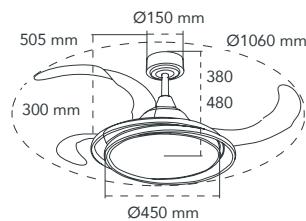

● MD-85-094-36 2xAAA 
○ MD-85-402-40 2xAAA

	1	2	3	4	5	6
	160	175	190	205	217	230
m³/h	6120	6850	7250	7900	8620	9680
(W)	9,5	14	17	25	28	30
	27	29	32	35	37	40

# Antila Mini



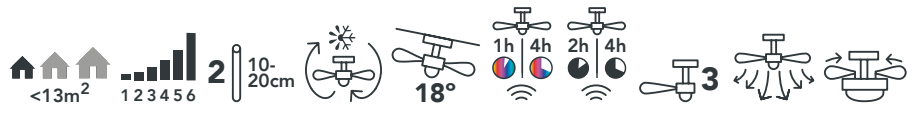

● ○ 85-094-36-000

★New★

● ● 85-094-36-180

★New★

● ● 85-094-36-281

★New★



○ 85-402-40-100

● 85-402-40-180

● 85-402-40-281

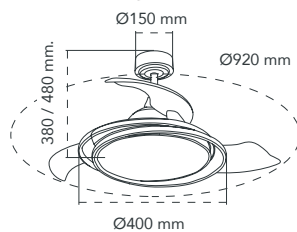

	1	2	3	4	5	6
	165	176	195	218	230	258
	3630	4550	5450	5880	6685	7165
	4	6	8,5	11	13	17
	29	30	33	36	38	41

● MD-85-094-36  
2xAAA

MD-85-402-40  
2xAAA

# Antila Mini XS



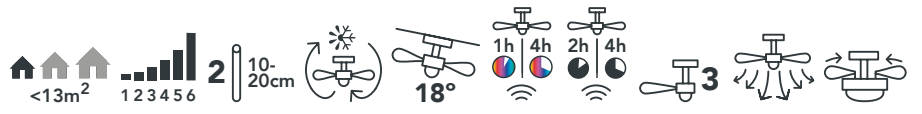

● ○ 85-094-22-100 **★New★**    
 ● ● 85-094-22-180 **★New★**    
 ● ● 85-094-22-281 **★New★**



○ 85-403-40-100

● 85-403-40-180

● 85-403-40-281

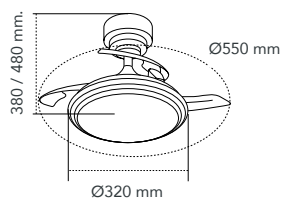

	1	2	3	4	5	6
	285	340	390	430	470	530
	3350	3860	4290	4880	5420	6000
	5	7	10	12,5	15	21
	29	30	31	34	37	40

● MD-85-094-22    MD-85-403-40  
 2xAAA    2xAAA

★New★

 MOTOR DC

 72W 7920Lm

# Lander





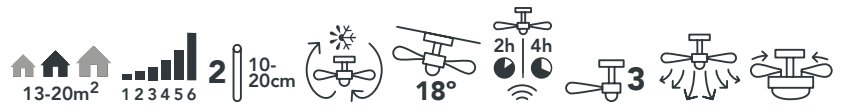

○ 85-011-42-000

● 85-011-42-180



● 85-011-42-281



MD-85-065-92  
2xAAA

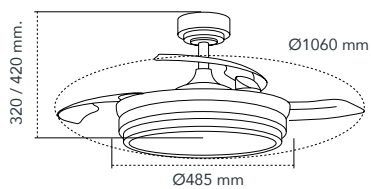

	1	2	3	4	5	6
	175	186	195	212	227	245
m³/h	3420	4050	4500	5760	6120	6700
(W)	6,8	8	9,5	14	18,2	29
	28	30	33	34	37	40

★New★

 MOTOR DC

 46W 5520Lm

# Lander Mini







○ 85-011-36-000

● 85-011-36-180



● 85-011-36-281



MD-85-065-46  
2xAAA

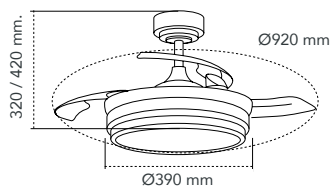

	1	2	3	4	5	6
	164	187	208	226	245	260
	2340	2520	3060	3600	4770	5580
	5	7.2	9.4	12.3	15.7	20
	27	29	32	33	36	39

★New★

 MOTOR DC

 72W 7920Lm

# Oku





○ 85-114-42-100

● 85-114-42-180



● 85-114-42-281



MD-85-065-92  
2xAAA

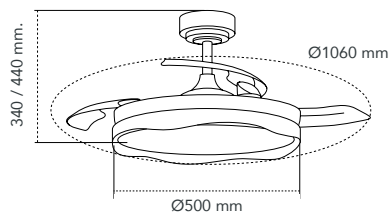

PC    
 Acero/Steel/Acier    
 PMMA    
 5,65 Kg    
 22 Uds.

	1	2	3	4	5	6
	175	186	195	212	227	245
m³/h	3420	4050	4500	5760	6120	6700
(W)	6,8	8	9,5	14	18,2	29
	28	30	33	34	37	40

# Aneto





○ 85-066-72-000

● 85-066-72-180

★New★

● 85-066-72-186

★New★



● 85-065-72-006

● 85-065-72-002



MD-85-065-92  
2xAAA

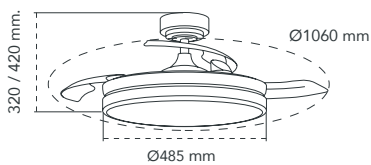

	1	2	3	4	5	6
	175	186	195	212	227	245
m³/h	3420	4050	4500	5760	6120	6700
(W)	6,8	8	9,5	14	18,2	29
	28	30	33	34	37	40



# Moss







○ 85-065-72-000

● 85-065-72-180

★New★

● 85-065-72-281

★New★



● 85-065-72-006

● 85-065-72-002



MD-85-065-92  
2xAAA

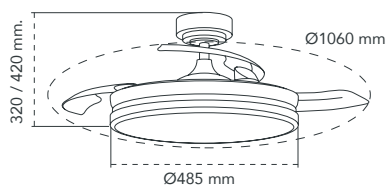

	1	2	3	4	5	6
	175	186	195	212	227	245
m³/h	3420	4050	4500	5760	6120	6700
(W)	6,8	8	9,5	14	18,2	29
	28	30	33	34	37	40

# Moss Mini



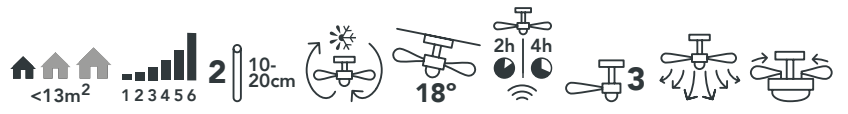

○ 85-065-46-000

● 85-065-46-180

★New★

● 85-065-46-281

★New★



● 85-065-46-006

● 85-065-46-002



MD-85-065-46  
2xAAA

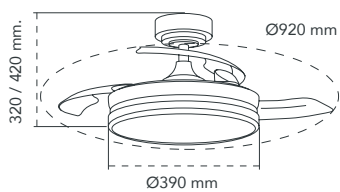

	1	2	3	4	5	6
	164	187	208	226	245	260
m <sup>3</sup> /h	2340	2520	3060	3600	4770	5580
(W)	5	7.2	9.4	12.3	15.7	20
	27	29	32	33	36	39

★New★

 MOTOR DC

 80W 9000Lm

# Moss XL



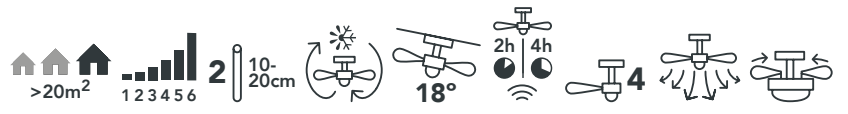

○ 85-068-45-100



MD-85-067-45  
2xAAA

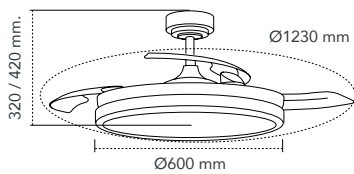

	1	2	3	4	5	6
	1	2	3	4	5	6
	160	178	190	203	218	228
m³/h	3890	4850	5880	6960	8040	8775
(W)	10	13	15	20	25	30
	29	32	33	36	38	42



★New★

 MOTOR DC

 50W 6000Lm

# Naira





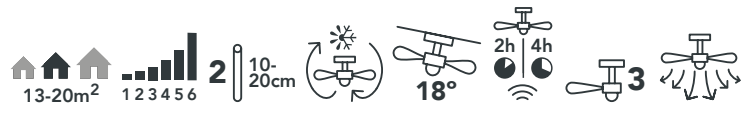

○ 85-301-10-100



● 85-301-10-180



MD-85-065-92  
2xAAA

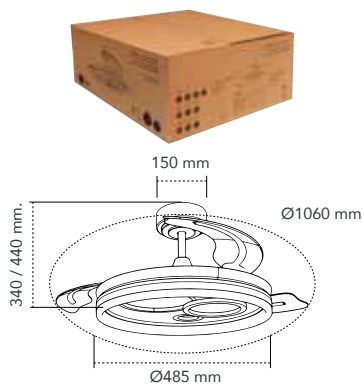

PC   
 Acero/Steel/Acier   
 PMMA   
 5,78 Kg   
 22 Uds.

	1	2	3	4	5	6
	175	186	198	212	227	245
m³/h	3420	4050	4500	5760	6120	6660
(W)	7	8	9	14	19	28
	26	27	30	33	36	38

★New★



 72W 7920Lm

# Movic





○ 85-101-42-106



MD-85-065-92  
2xAAA

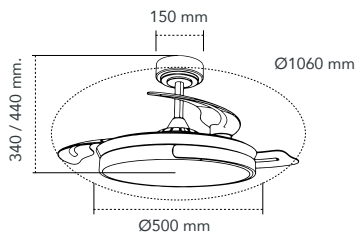

PC   
 Acero/Steel/Acier   
 PMMA   
 5,66 Kg   
 22 Uds.

	1	2	3	4	5	6
	175	186	198	212	227	245
m³/h	3420	4050	4500	5760	6120	6660
(W)	7	8	9	14	19	28
	26	27	30	33	36	38

★New★

 MOTOR DC

 72W 7920Lm

# Panam





○ ● 85-021-42-102



○ ● 85-021-42-106



○ ● 85-021-42-180



○ ● 85-021-42-188



MD-85-065-92  
2xAAA

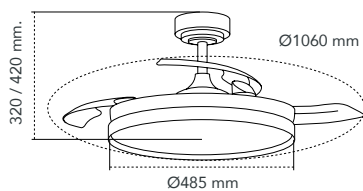

	1	2	3	4	5	6
	175	186	195	212	227	245
	3420	4050	4500	5760	6120	6700
	6,8	8	9,5	14	18,2	29
	28	30	33	34	37	40

★New★

 MOTOR DC

 46W 5520Lm

# Panam Mini





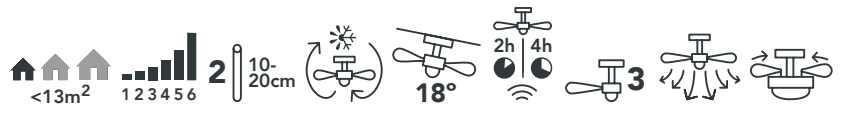

○ ● 85-021-36-106



○ ● 85-021-36-180



○ ● 85-021-36-102



○ ● 85-021-36-188



MD-85-065-46  
2xAAA

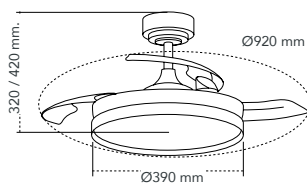

	1	2	3	4	5	6
	164	187	208	226	245	260
m <sup>3</sup> /h	2340	2520	3060	3600	4770	5580
(W)	5	7.2	9.4	12.3	15.7	20
	27	29	32	33	36	39

★New★

 MOTOR DC

 45W 4400Lm

# Supereco





○ 85-069-42-000



● 85-069-42-180



MD-85-069-42  
2xAAA



	1	2	3	4	5	6
	175	186	198	212	227	245
m³/h	3750	3940	4380	4870	5340	5730
(W)	6,8	8	9,5	14	18,5	29
	30	32	35	37	39	42

★New★

 MOTOR DC

 45W 4400Lm

# Ecoro



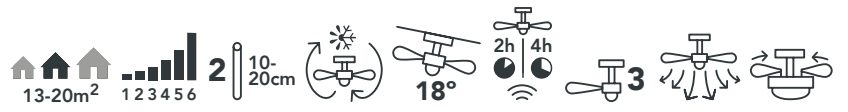

○ 85-069-25-100

● 85-069-25-180

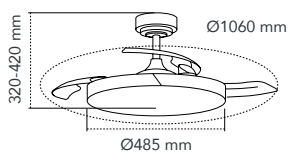

MD-85-069-42  
2xAAA

ABS   
 Acero/Steel/Acier   
 PMMA   
 2,35 Kg   
 22 Uds.

	1	2	3	4	5	6
	175	186	198	212	227	245
m³/h	3750	3940	4380	4870	5340	5730
(W)	6,8	8	9,5	14	18,5	29
	30	32	35	37	39	42



★New★

 MOTOR DC

 18W 2400Lm

# Villa





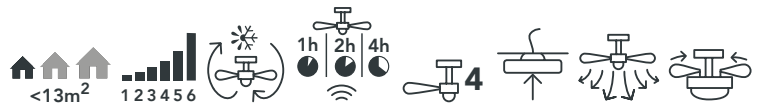

○ 85-007-20-100



MD-85-007-20-100  
2xAAA

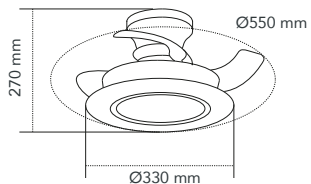

	1	2	3	4	5	6
	299	340	379	420	461	519
	4500	5520	6180	6960	7440	8160
	7,2	8,9	11,3	13,8	16,8	23
	34	36	38	40	42	45

★New★

 MOTOR DC

 20W 1900Lm

# Moll



**Fácil instalación**  
*Easy installation*  
*Installation facile*





○ 85-401-22-100



○ ● 85-401-22-106



● 85-401-22-180



● ● 85-401-22-188



MD-85-400-22  
2xAAA



	1	2	3	4	5	6
	255	285	315	345	365	400
m³/h	3750	4460	5190	5780	6230	6780
(W)	9	11	15	17	21	25
	28	31	33	36	38	40

★New★



20W 1900Lm

# Reel



**Fácil instalación**  
*Easy installation*  
*Installation facile*







○ 85-400-22-100



● 85-400-22-180



### Ventiladores con aspas

Son atemporales, inunca pasan de moda y cumplen con todas tus necesidades!

#### **Fans with blades**

*They are timeless, never go out of fashion and meet all your needs!*

#### **Ventilateurs à pales**

*Ils sont intemporels, ne se démodent jamais et répondent à tous vos besoins!*



MD-85-400-22  
2xAAA

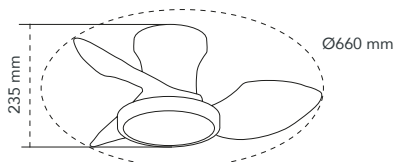

	1	2	3	4	5	6
	255	285	315	345	365	400
m³/h	3750	4460	5190	5780	6230	6780
(W)	9	11	15	17	21	15
	28	31	33	36	38	40

★New★



20W 2000Lm

# Julie







○ 85-104-66-100



○ ● 85-104-66-102



MD-85-104-66  
2xAAA

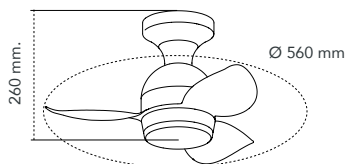

	1	2	3	4	5	6
	200	228	260	290	320	350
m <sup>3</sup> /h	4500	5520	6180	6960	7440	8160
(W)	3,24	4,2	5,56	6,98	9,66	12,89
	34	36	38	40	42	45

★New★

 MOTOR DC

 20W 2000Lm

# Epona





○ 85-102-22-100



● 85-102-22-180



○ ● 85-102-22-106



● ● 85-102-22-188



MD-85-102-22  
2xAAA

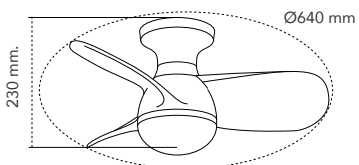

ABS   
 Acero/Steel/Acier   
 PVC   
 2,6 Kg   
 75 Uds.

	1	2	3	4	5	6
	255	285	315	345	365	400
m³/h	3670	4350	5090	5650	6100	6800
(W)	9	11	15	17	21	25
	29	33	35	38	40	42

★New★

 MOTOR DC

 18W 2000Lm

# Byan



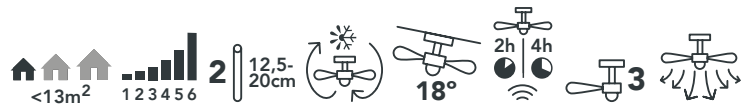

○ 85-108-92-100



● 85-108-92-180



○ ● 85-108-92-105



○ ● 85-108-92-102



MD-85-108  
2xAAA

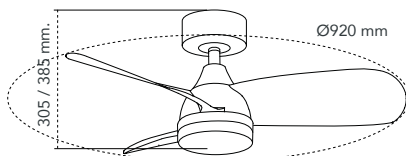

	1	2	3	4	5	6
	1	2	3	4	5	6
	140	152	165	175	190	205
m <sup>3</sup> /h	3560	4560	6270	7025	8550	9720
(W)	10	12	15	17	25	29
	44	45	46	47	49	51



★New★



18W 2000Lm

# Byan Mini







○ 85-108-60-100



● 85-108-60-180



○ ● 85-108-60-105



○ ● 85-108-60-102



MD-85-108  
2xAAA

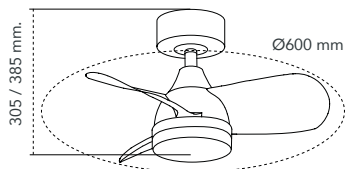

	1	2	3	4	5	6
	226	260	290	320	360	400
m <sup>3</sup> /h	3840	4560	5400	6180	6900	7680
(W)	6	8.5	10	14	20	29
	44	46	48	52	56	60

★New★



20W 1900Lm

# Stel Mini S



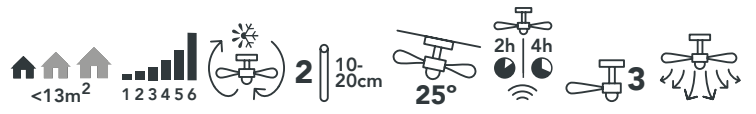

○ 85-915-20-100



○ ● 85-915-20-106



● 85-915-20-180



● ● 85-915-20-188



MD-85-915-20  
2xAAA

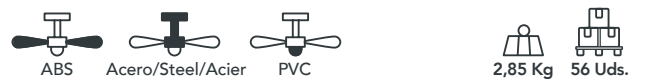
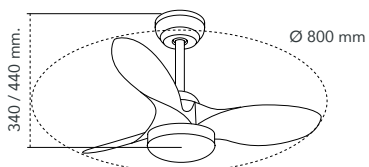

	1	2	3	4	5	6
	180	200	220	240	260	280
m <sup>3</sup> /h	3670	4350	5090	5650	6320	7270
(W)	7,2	9,5	12,2	16	19,5	26
	24	27	31	34	37	41

★New★

 MOTOR DC

 20W 1900Lm

# Stel Mini



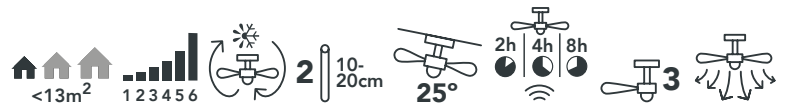

○ 85-925-20-100



○ ● 85-925-20-106



● 85-925-20-180



● ● 85-925-20-188



MD-85-925-20  
2xAAA

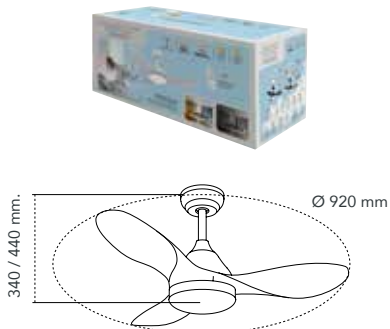

ABS   
 Acero/Steel/Acier   
 PVC   
 2,85 Kg   
 42 Uds.

	1	2	3	4	5	6
	1	2	3	4	5	6
	130	163	194	224	253	283
m <sup>3</sup> /h	4320	5400	6450	7560	8560	9540
(W)	5	7	9	12	16	21
	23	26	29	32	35	37



★New★

 MOTOR DC

 20W 1900Lm

# Stel







○ 85-950-20-100



○ ● 85-950-20-106



● 85-950-20-180



● ● 85-950-20-188



MD-85-950-20  
2xAAA

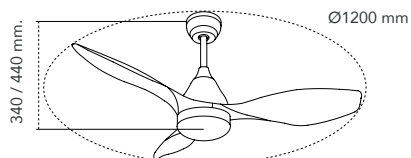

ABS   
 Acero/Steel/Acier   
 PVC   
 5,65 Kg   
 36 Uds.

	1	2	3	4	5	6
	90	100	125	150	175	200
m³/h	6480	7360	8280	9180	10860	11750
(W)	4	5	8	12	25	28
	24	27	30	33	36	38

★New★

 MOTOR DC

 Natural Wood  20W 1900Lm

# Beta



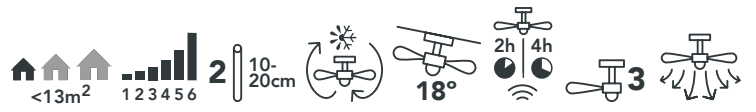

○ ● 85-090-36-106



### Madera Natural

Nuestras palas están fabricadas con maderas certificadas y sostenibles.

#### Natural wood

*Our shovels are made with wood certified and sustainable.*

#### Bois naturel

*Nos pelles sont fabriquées en bois certifié et durable.*



MD-85-090-36  
2xAAA

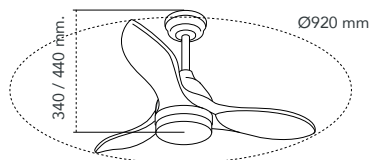

Madera/Wood/Bois    
 Acero/Steel/Acier    
 PMMA    
 4,8 Kg    
 42 Uds.

	1	2	3	4	5	6
	127	150	175	195	223	255
m <sup>3</sup> /h	4980	5650	6190	6850	7520	8230
(W)	8	11	15	19	24	27
	31	34	36	39	43	46

# Terre





○ ● 85-908-42-100

★New★

● ● 85-908-42-180

★New★



● ● 85-908-42-115



MD-85-908-24  
2xAAA

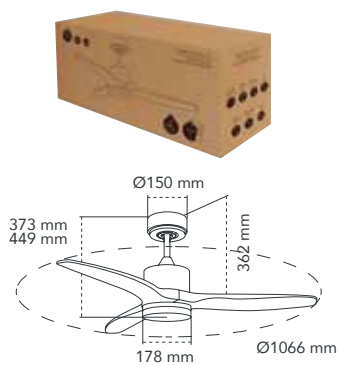

Madera/Wood/Bois 
 Acero/Steel/Acier 
 Acrílico/Acrylic/Acrylique 
 5,27 Kg 
 30 Uds.

	1	2	3	4	5	6
	150	170	190	220	240	260
m³/h	1800	2400	3000	3900	4800	6000
(W)	3	4	5	7	9	12
	43	44	44	45	46	47



# Noe





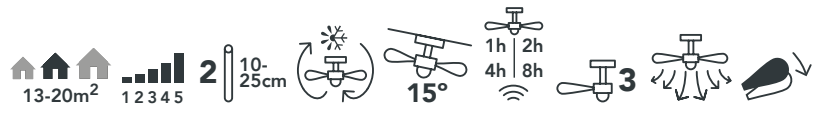

○ ● 85-303-18-111



MD-85-303-18  
2xAAA

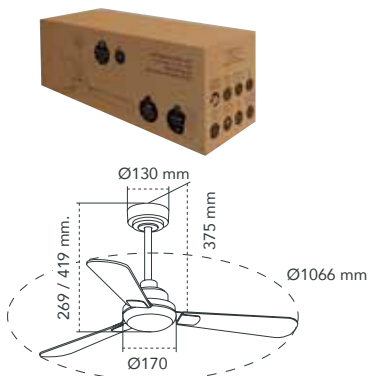

Plywood   
 Acero/Steel/Acier   
 Acrílico/Acrylic/Acrylique   
 5,5 Kg   
 30 Uds.

	1	2	3	4	5
	1	2	3	4	5
	112	146	180	215	240
m³/h	4658	5369	6059	6845	7533
(W)	3	5,70	8,70	12,30	17,60
	30	35	38	42	50

# Tanik



OPCIONAL/OPTIONAL  
KIT SMART VENT





○ 85-160-25-100



● 85-160-25-115



● 85-160-25-281



MD TANIK  
1x12V

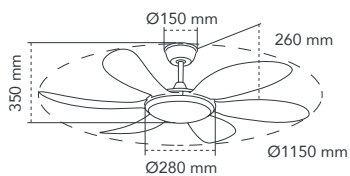

	1	2	3	4	5
	85	120	140	165	185
m³/h	4800	5700	6480	6900	7200
(W)	4,60	8	11	18	25
	21	24	27	30	35

# Tempo



OPCIONAL/OPTIONAL  
KIT SMART VENT



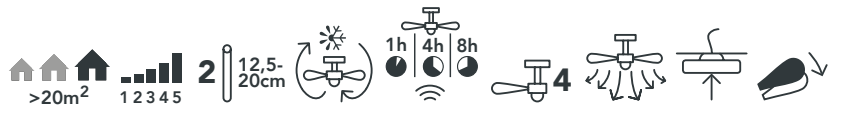

○ ● 85-485-52-100



**Dos acabados diferentes**

Blanco/madera oscura

*Two different finishes*

*White/dark wood*

*Deux finitions différentes*

*Blanc/bois foncé*

● ● 85-485-52-281



**Dos acabados diferentes**

Plata/madera clara

*Two different finishes*

*Silver/clear wood*

*Deux finitions différentes*

*Argent/bois clair*



MD-85-636-18  
1x12V

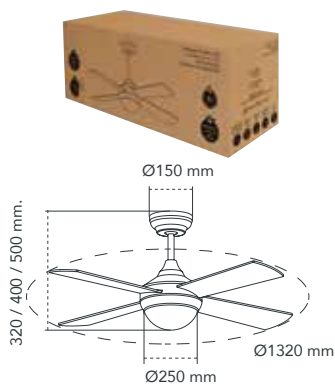

	1	2	3	4	5
	1	2	3	4	5
	92	125	153	174	200
	3060	5043	5890	7890	9350
	5,50	9,50	14,80	20,20	34,50
	25	32	40	45	50

# Aran







○ 85-657-36-100



MD-85-657-36  
1x12V

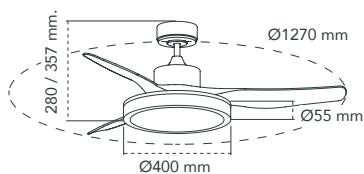

	1	2	3	4	5	6
	1	2	3	4	5	6
	110	130	150	170	190	210
	4200	6000	7200	8400	10200	11400
	6	10	14	21	31	42
	43	44	46	47	48	50

# Lighter



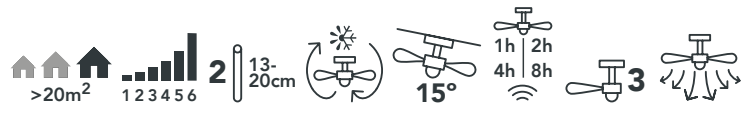

○ 85-203-24-100



MD-85-203-24  
2xAAA

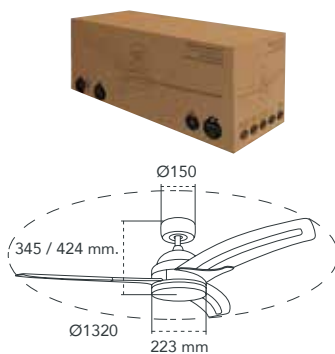

	1	2	3	4	5	6
	90	125	145	160	185	200
m³/h	3600	6300	8400	9600	10800	12600
(W)	5	7	10	13	19	28
	40	42	43	45	46	48

# Surat





● ○ 85-010-20-200



○ 85-010-20-100



MD-85-010-24  
2xAAA

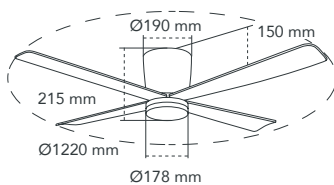

Plywood    
 ABS    
 Acrílico/Acrylic/Acrylique    
 4,3 Kg    
 28 Uds.

	1	2	3	4	5	6
	75	88	108	125	145	155
m³/h	4069	6533	8884	11213	12139	13090
(W)	4,3	8,8	16	24	34	46
	33	34	36,6	39,7	43,2	47

★New★



24W 2400Lm

# Enna







○ ● 85-002-52-100



● ● 85-002-52-180



MD-85-002-52  
2xAAA

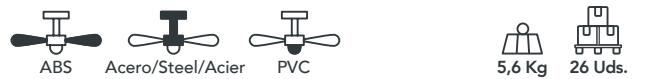
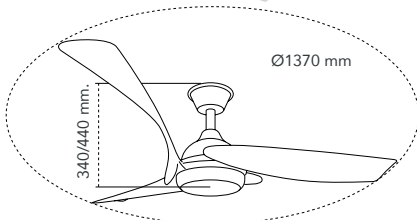

	1	2	3	4	5	6
	1	2	3	4	5	6
	83	105	119	139	165	180
m³/h	4500	5000	5800	6900	7900	10980
(W)	9	13	16	20	25	28
	29	32	34	37	39	41

# Taga





● ● 85-030-20-180



MD-85-030-20  
2xAAA

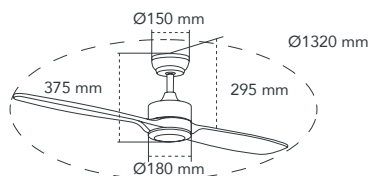

5,8 Kg 26 Uds.

	1	2	3
	160	200	220
m³/h	4560	6000	9100
(W)	17	30	46
	25	32	36

# Yen





○ ● 85-020-20-000

★New★



● ● 85-020-20-180

★New★



● ● 85-020-20-002



● ● 85-020-20-003



MD-85-020-24  
2xAAA

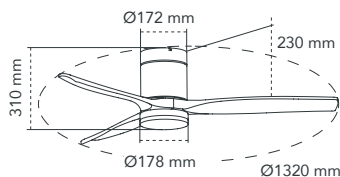

Madera/Wood/Bois  
 Acero/Steel/Acier  
 Acrílico/Acrylic/Acrylique  
 6 Kg  
 28 Uds.

	1	2	3	4	5	6
	1	2	3	4	5	6
	80	109	139	158	177	200
m <sup>3</sup> /h	4656	6054	7935	9336	10737	12614
(W)	4	7,10	11,80	17	23,80	34,60
	33	34	37	40	43	47



# Yen Big





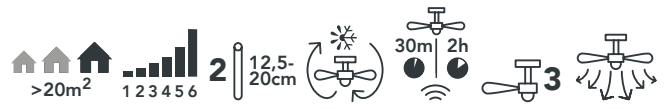

● 85-060-03-002



● 85-060-03-003

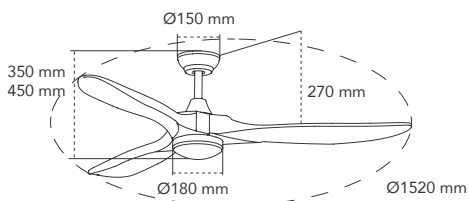

MD-85-020-24  
2xAAA

Madera/Wood/Bois  
 Acero/Steel/Acier  
 Acrílico/Acrylic/Acrylique  
 6,2 Kg  
 18 Uds.

	1	2	3	4	5	6
	75	88	108	125	145	155
m³/h	4655	5131	8240	9811	11213	13541
(W)	6	9	14,50	22	32	42,70
	33	34	37	40	43	47

★New★

 MOTOR DC

 Natural Fibers  25W 2200Lm

# Palm



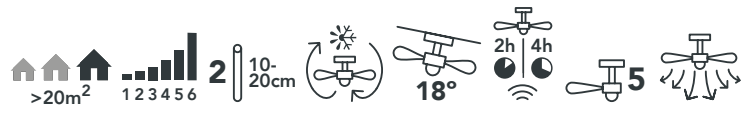

○ ● 85-091-52-108



MD-85-091-52  
2xAAA

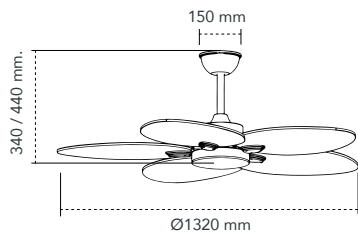

Natural   
 Acero/Steel/Acier   
 PMMA   
 6,9 Kg   
 26 Uds.

	1	2	3	4	5	6
	80	91	98	107	118	125
m³/h	3190	3385	3580	3860	4170	4360
(W)	18	23	28	33	36	40
	29	32	35	38	41	44

# Storm

  
IP 44  5



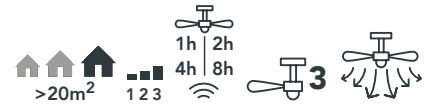

○ 85-040-03-100



MD-85-030-20  
2xAAA

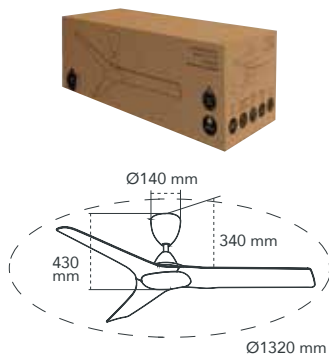

	1	2	3
	1	2	3
	100	140	195
m³/h	6850	8350	11500
(W)	24	43	78
	25	30	43



# Tabit





○ 85-790-06-100



● 85-790-06-115



● 85-790-06-281



● 85-790-06-666



MD-VENTI-UNIVERSAL  
2xAAA

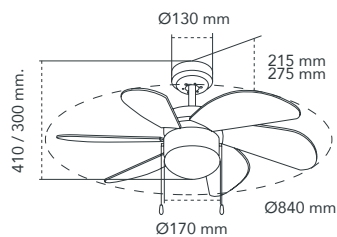

	1	2	3
	155	194	238
m <sup>3</sup> /h	3540	4140	5940
(W)	22	35	55
	30	42	52

# Orion





○ ● 85-990-06-111



**Palas reversibles**  
Blanco/ceniza  
**Reversible blades**  
White/ash  
**Lames réversibles**  
Blanc/ash

● ● ● 85-990-06-666



**Palas reversibles**  
Pastel/multicolor  
**Reversible blades**  
Pastel/multicolour  
**Lames réversibles**  
Pastel/multicolore



MD-VENTI-UNIVERSAL  
2xAAA

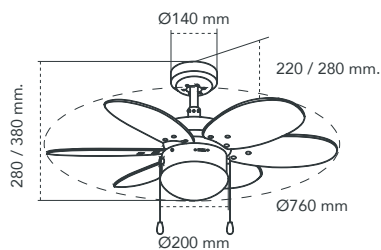

	1	2	3
	128	192	238
m <sup>3</sup> /h	2900	4050	5810
(W)	15	26	51
	31	41	45

★New★



20W 2000Lm

# Bigben







● 85-960-18-106



● Opcional sin luz  
Ref. 85-960-disco

● 85-960-25-106



Aluminio/Aluminum/Aluminium Acero/Steel/Acier PMMA 12,59 Kg 16 Uds.

Ref. 85-960-18-106 Ø1800 mm

	1	2	3	4	5	6
	47	55	64	76	84	96
	5525	6695	7865	8890	9880	11115
	8,2	9,9	14,2	20,2	28,5	39,3
	26,5	28,3	30,4	32,8	35,7	39,6

Ref. 85-960-25-106 Ø2500 mm

16,71 Kg 12 Uds.

	1	2	3	4	5	6
	51	73	86	95	103	108
	11174	15358	17619	19525	21292	23812
	12,9	33,3	53,7	74,2	95,2	116,5
	28	31	34	37	40	43



MD-85-020-24  
2xAAA

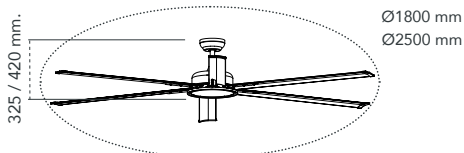

★New★



50W 4800Lm

# Strike





● 85-922-50-180





**Tres tonos de luz**  
 En el mismo plafón: Blanco cálido, blanco neutro y blanco frío.

**Three light tones**  
 On the same ceiling: Warm white, white neutral and cold white.

**Trois couleurs de lumière**  
 Au même plafond: Blanc chaud, blanc blanc neutre et froid.

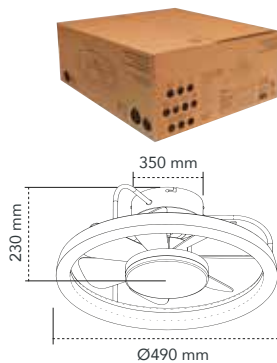

MD-85-922-50  
 2xAAA



	PC	PMMA	Hierro/Iron/Fer			
					2,95 Kg	30 Uds.
	1	2	3	4	5	6
	300	360	420	475	520	600
	1800	2200	2800	3200	3500	4300
	4.2	6.1	8.7	12	14.8	21
	30	32	34	36	37	39

★New★

 MOTOR DC

 50W 4800Lm

# Cobra

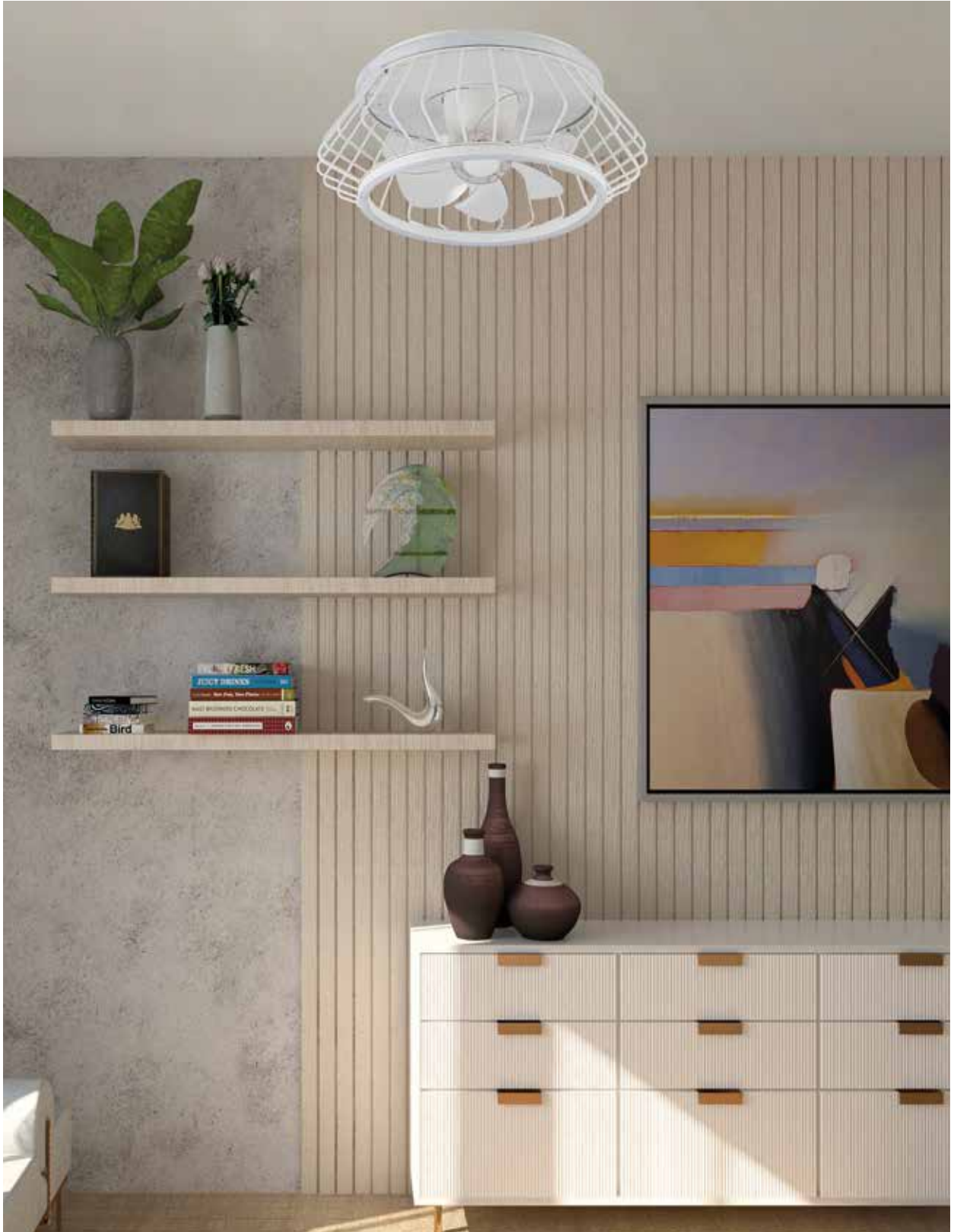





○ 85-924-30-100



● 85-924-30-180

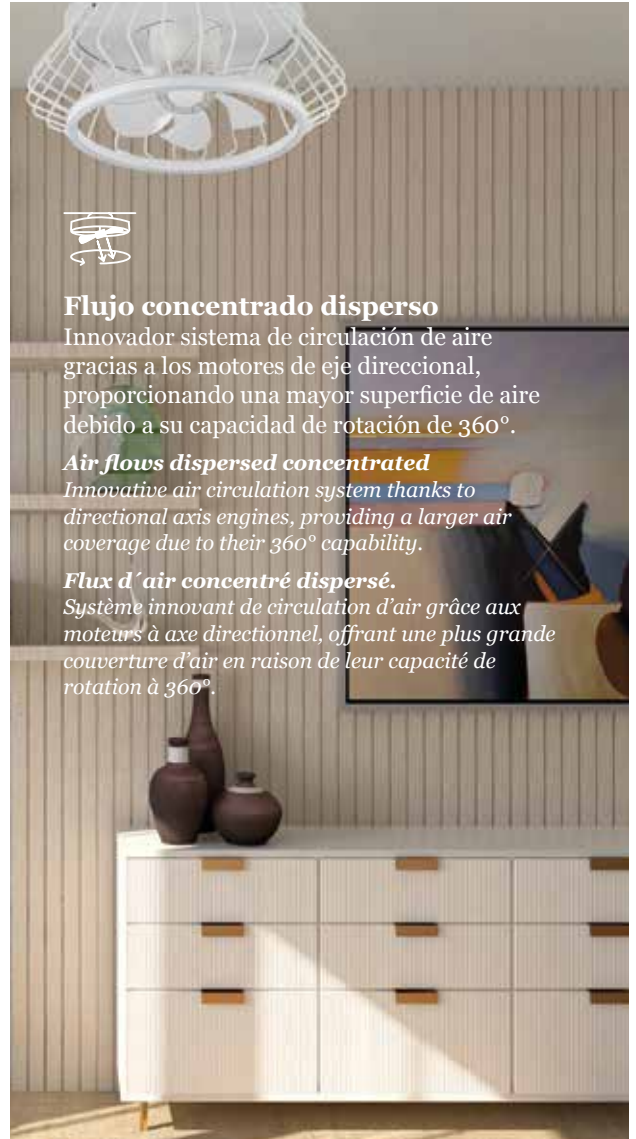

### Flujo concentrado disperso

Innovador sistema de circulación de aire gracias a los motores de eje direccional, proporcionando una mayor superficie de aire debido a su capacidad de rotación de 360°.

### Air flows dispersed concentrated

Innovative air circulation system thanks to directional axis engines, providing a larger air coverage due to their 360° capability.

### Flux d'air concentré dispersé.

Système innovant de circulation d'air grâce aux moteurs à axe directionnel, offrant une plus grande couverture d'air en raison de leur capacité de rotation à 360°.



MD-85-009-50  
2xAAA

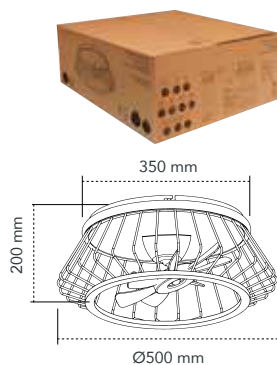

	1	2	3	4	5	6
	1	2	3	4	5	6
	695	760	830	900	970	1040
m <sup>3</sup> /h	1400	1800	2500	3100	3400	3800
(W)	3.7	4.8	6	7.5	9.3	11.5
	30	32	35	38	40	42



★New★



50W 4800Lm

# Dinirot





○ 85-009-50-100



● 85-009-50-180



MD-85-009-50  
2xAAA

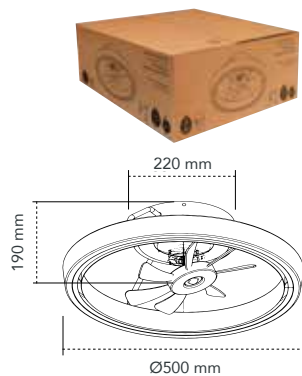

	1	2	3	4	5	6
	600	670	740	810	880	950
m <sup>3</sup> /h	1400	1800	2500	3100	3400	3800
(W)	3.7	4.8	6	7.5	9.3	11.5
	30	33	36	38	40	42

★New★

 MOTOR DC

 50W 5200Lm

# Tivoli

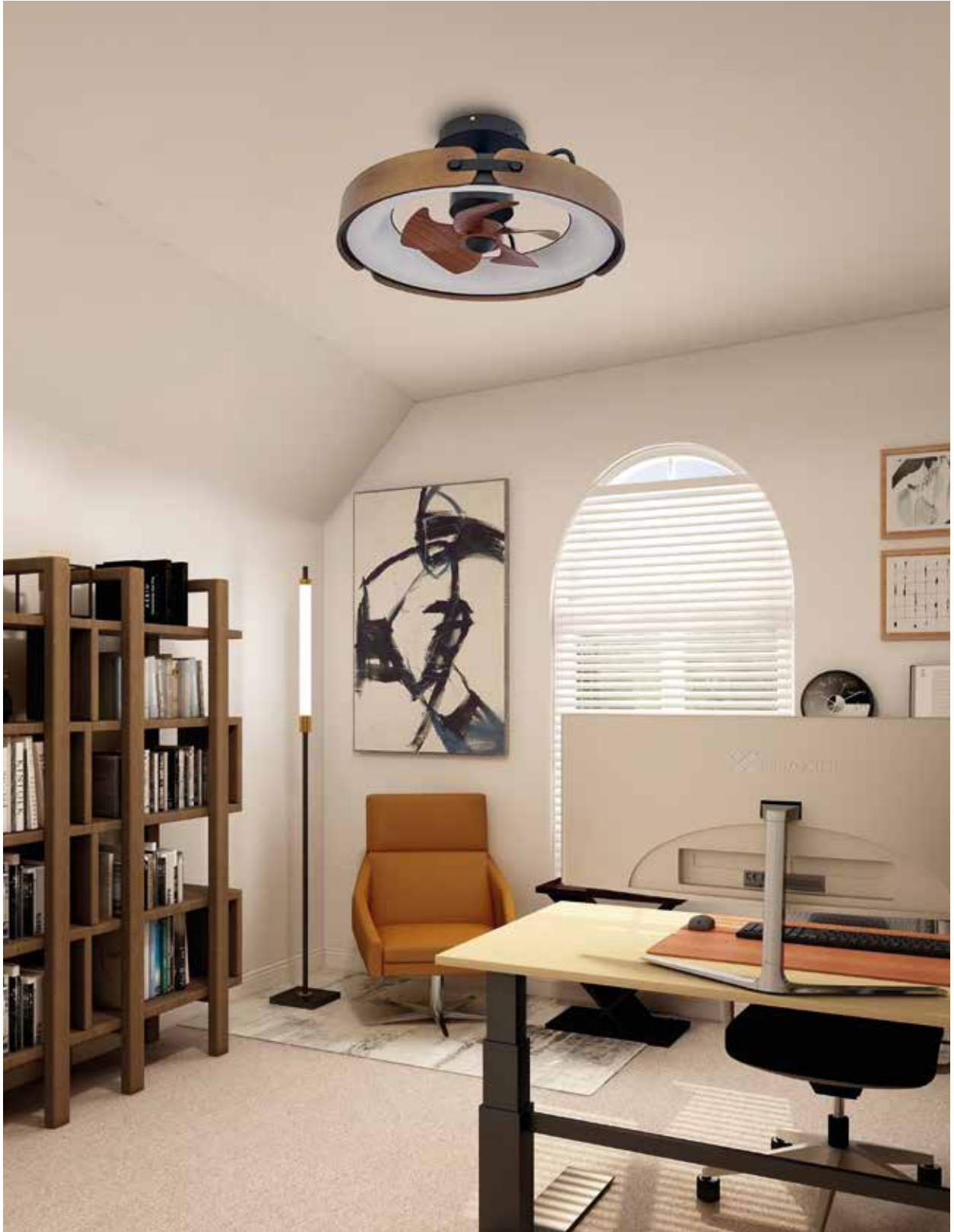



● ● 85-917-52-106



### Función inversa invierno

Girando en sentido antihorario hace descender el aire caliente.

#### Reverse functions winter

Turning anticlockwise causes the warm air to descend.

#### Fonction inverse hiver

Le ventilateur En tournant dans le sens inverse des aiguilles d'une montre, on abaisse l'air chaud.



### Función inversa verano

El ventilador gira en sentido horario creando un flujo de aire frío descendente.

#### Reverse functions summer

The fan rotates clockwise creating a downward flow of cold air.

#### Fonction inverse été

Le ventilateur tourne dans le sens des aiguilles d'une montre, créant un flux d'air froid descendant.



MD-85-917-52  
2xAAA

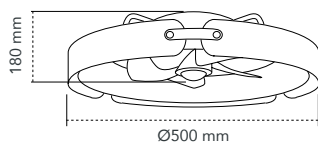

PC



PMMA



Hierro/Iron/Fer



2,75 Kg



22 Uds.

	1	2	3	4	5	6
	695	760	830	900	970	1040
m <sup>3</sup> /h	1400	1800	2500	2900	3100	3400
(W)	3.7	4.8	6	7.5	9.3	11.5
	30	33	36	38	40	42



# Corpi







○ 85-201-35-000



### Tecnología Smart

Ahora tu ventilador puede ser controlado desde tu móvil.

#### Smart Technology

Now your fan can be controlled from your mobile phone.

#### Smart Technologie

Maintenant, votre ventilateur peut être contrôlé sur votre téléphone portable.



MD-85-210-35  
2xAAA

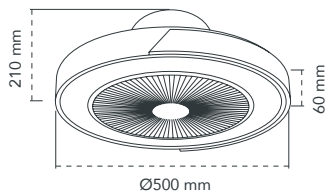

ABS   
 Acrílico/Acrylic/Acrylique   
 PVC/Madera/Wood/Bois   
 3,4 Kg   
 18 Uds.

	1	2	3	4	5	6
	560	670	760	870	970	1070
m <sup>3</sup> /h	4400	5200	5600	6050	6500	7200
(W)	3,50	4,50	6,10	8,90	12,30	16,50
	22	26	28	30	34	38

# Moli





# Iris





○ 85-589-36-100





**Altavoz bluetooth**  
Ahora también puedes escuchar tu música preferida a través de tu ventilador bluetooth.

**Bluetooth speaker**  
*Now you can also listen to your favorite music through your Bluetooth fan.*







**Haut-parleur Bluetooth**  
*Désormais, vous pouvez également écouter votre musique préférée via votre ventilateur Bluetooth.*

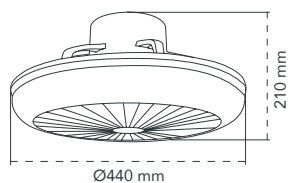



MD-85-589-36  
2xAAA 



	ABS	Acrílico/Acrylic/Acrylique	PVC			
				1,8 Kg		
					26 Uds.	
	1	2	3	4	5	6
	505	660	740	870	990	1180
	3200	3900	4900	5300	5500	6100
	6	8	10	13	15	18
	28	30	33	35	38	45



★New★



50W 4800Lm

# Rafale





● 85-921-40-180



### Ventiladores tipo plafón

Con las palas protegidas por una estructura exterior son ideales para habitaciones infantiles.

#### **Flush ceiling fan**

With the blades protected by an external structure, they are ideal for children's rooms.

#### **Ventilateurs de plafond**

Plus de la fonction Avec les lames protégées par une structure externe, ils sont idéaux pour les chambres d'enfants.



PC



PMMA



Hierro/Iron/Fer



	1	2	3	4	5	6
	695	760	830	900	970	1040
m <sup>3</sup> /h	1300	1500	2100	2300	2500	2900
(W)	3.7	4.8	6	7.5	9.3	11.5
	30	32	35	38	40	42



MD-85-917-52  
2xAAA

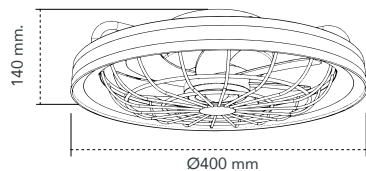



★New★



 Natural Fibers

# Greip

 5 años



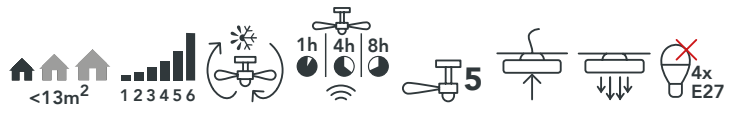

● ● 85-003-04-180

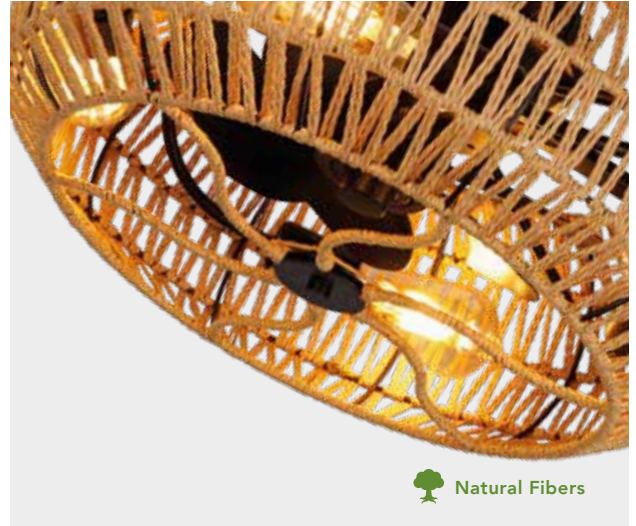

MD-85-003-04  
2xAAA

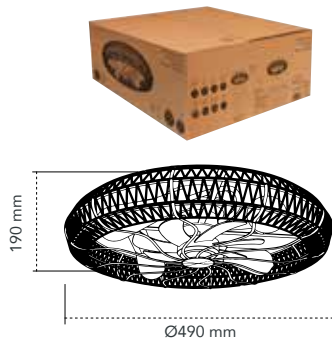

	1	2	3	4	5	6
PC						
Hierro/Iron/Fer Natural						
3,55 Kg						
22 Uds.						
	1	2	3	4	5	6
	695	760	830	900	970	1040
m <sup>3</sup> /h	1300	1500	2100	2300	2500	2900
(W)	3.7	4.8	6	7.5	9.3	11.5
	30	32	35	38	40	42

# Yoli

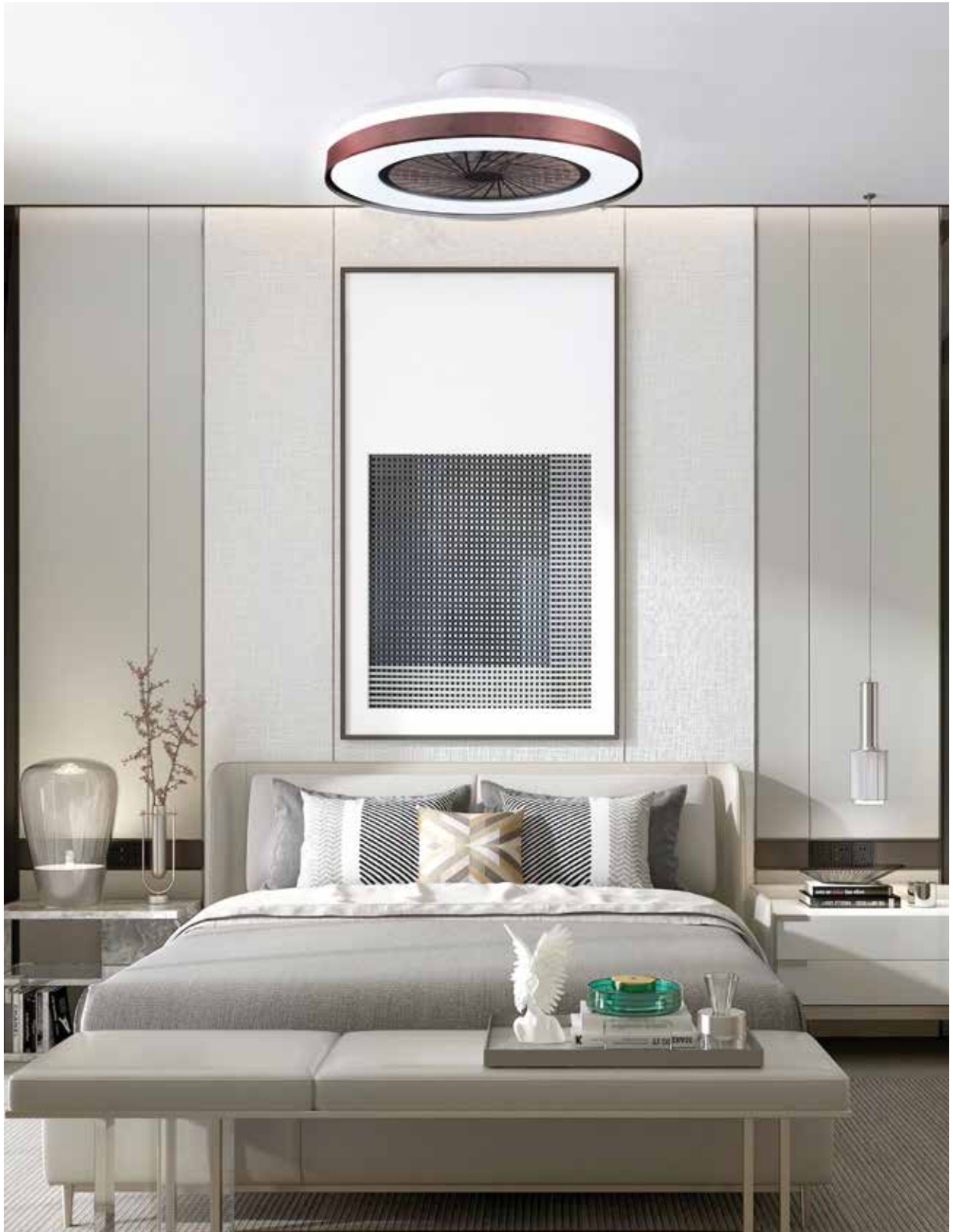





○ ● 85-503-40-115

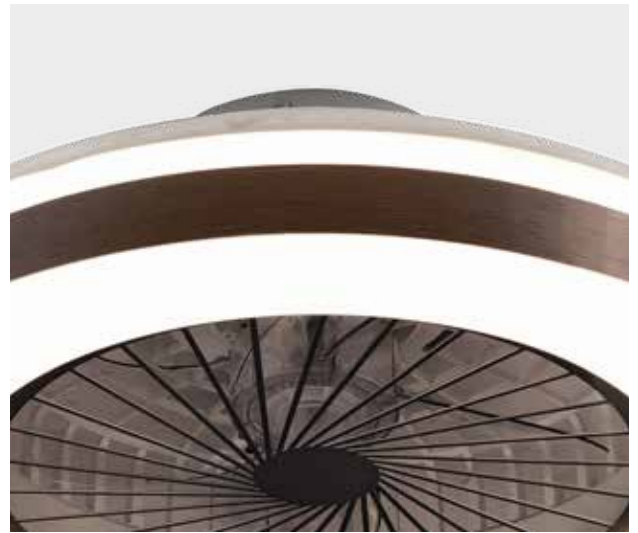

○ ● 85-503-40-281



MD-VT-DC-PY2C50  
2xAAA

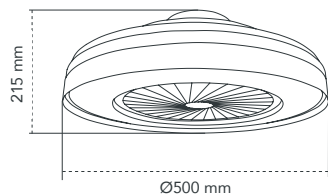

ABS   
 Acrílico/Acrylic/Acrylique   
 PVC   
 3,23 Kg   
 18 Uds.

	1	2	3	4	5	6
	500	600	700	800	900	1000
m <sup>3</sup> /h	3480	4200	5280	5880	6360	6780
(W)	3,60	4,40	5,60	7,10	9,40	12,10
	23	26	30	37	43	48

★New★

PORTATIL

5,5 W

# Splash

3 LED

85-000-12-000



Ventilador portátil con batería  
Portable fan with battery  
Ventilateur portable avec batterie

Cristalrecored Ventilación 2024

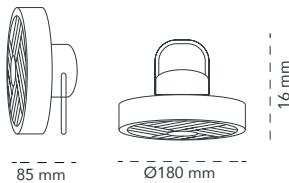

Ventilador  
Fan  
Ventilatur

Luz de Noche  
Night light  
Lumière de nuit

2 100% Intensidades  
Step Light  
50% Intensités de



25h/11h/6h

4,5h

195.565 Lithium  
1200mAh

★New★

PORTATIL

5,5 W

# Brise

3 LED

85-002-80-000

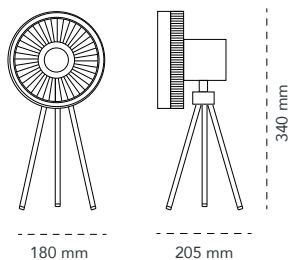

100% Intensidades  
66% Step Light  
34% Intensités de

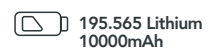

★New★



18W 2000Lm

# Nikiya E27

Base de instalación no incluida.





○ 85-970-30-100



●●● 85-970-30-666



Material PMMA

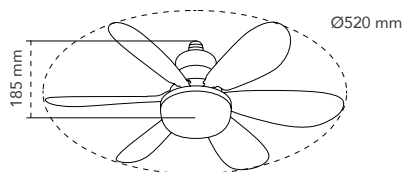

MD-85-970  
1xCR2025 ☺





Pol. Ruiseñores I  
Ctra. de Logroño, km. 8,5  
50011 Zaragoza. Spain  
+34 976 459 277

[www.cristalrecord.com](http://www.cristalrecord.com)  
[pedidos@cristalrecord.com](mailto:pedidos@cristalrecord.com)  
[orders@cristalrecord.com](mailto:orders@cristalrecord.com)

Síguenos





# Ventilación

Fan • Ventilateur

## 2024



Pol. Ruiseñores I  
Ctra. de Logroño, km. 8,5  
50011 Zaragoza. Spain  
+34 976 459 277

[www.cristalrecord.com](http://www.cristalrecord.com)  
[pedidos@cristalrecord.com](mailto:pedidos@cristalrecord.com)  
[orders@cristalrecord.com](mailto:orders@cristalrecord.com)